

# RACS 5 System Kontroli Dostępu

## Tablica Demonstracyjna DB-6A

**roger**

Intelligence for Building

**MCT12M-IO**  
Czytnik zbliżeniowy z klawiaturą i wbudowanymi liniami we/wy

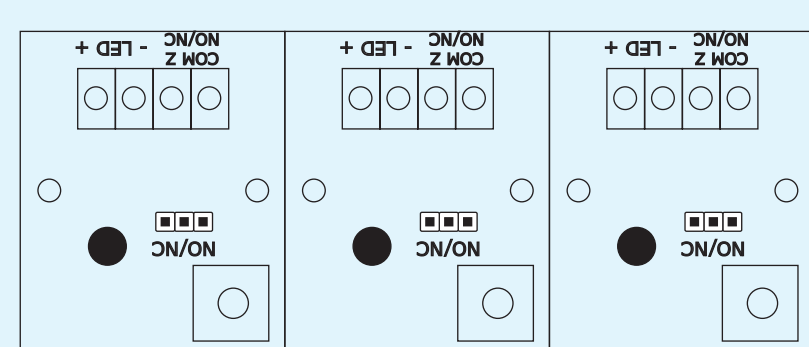
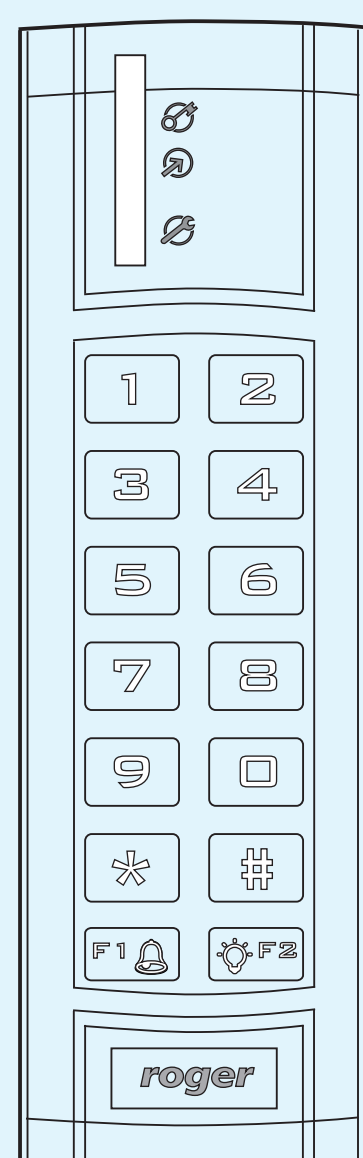

IN1/OUT1 IN2/OUT2 IN3/REL1

**MCT12M**  
Czytnik zbliżeniowy z klawiaturą

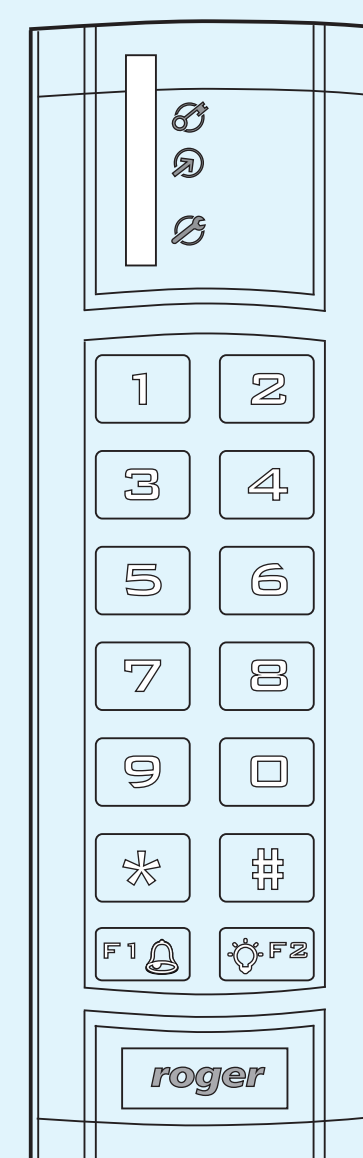

**MCT82M-IO**  
Czytnik zbliżeniowy z klawiaturą i wbudowanymi liniami we/wy

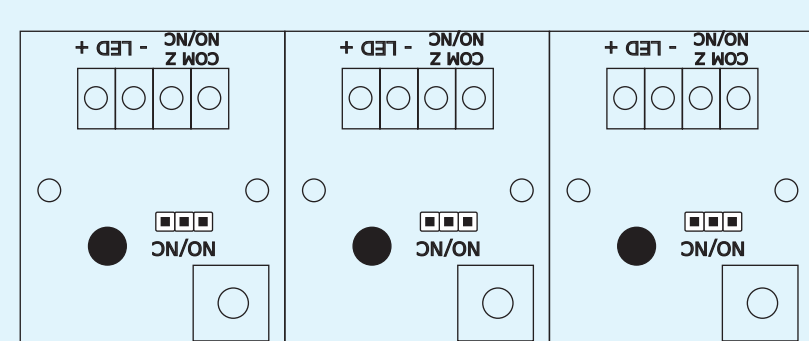

IN1/OUT1 IN2/OUT2 IN3/REL1

**MCT82M**  
Czytnik zbliżeniowy z klawiaturą

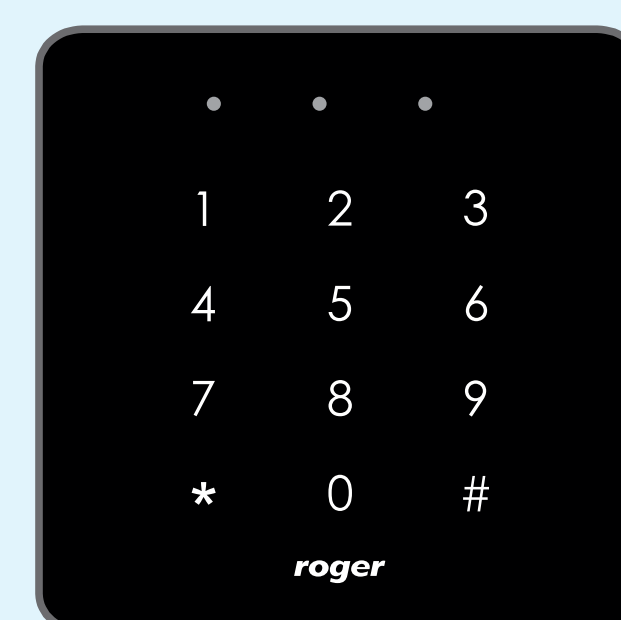

**MCT80M-BLE**  
Czytnik zbliżeniowy z obsługą NFC i BLE

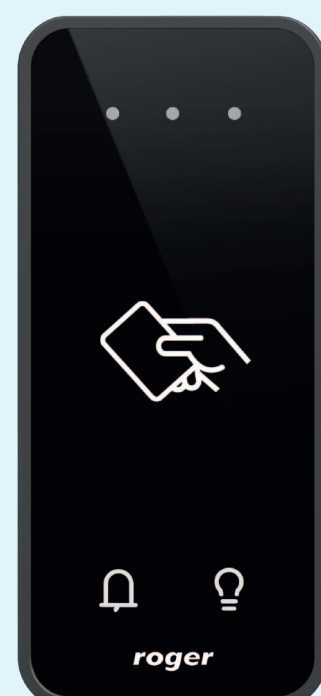

**MCT84M**  
Czytnik zbliżeniowy z klawiaturą

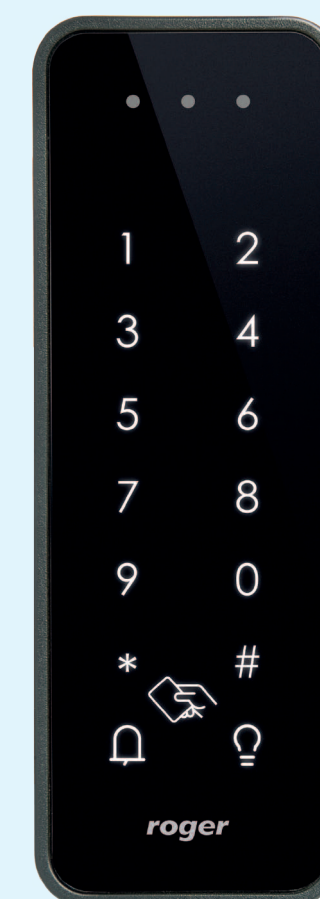

**MCX8-BRD**  
Ekspander we/wy

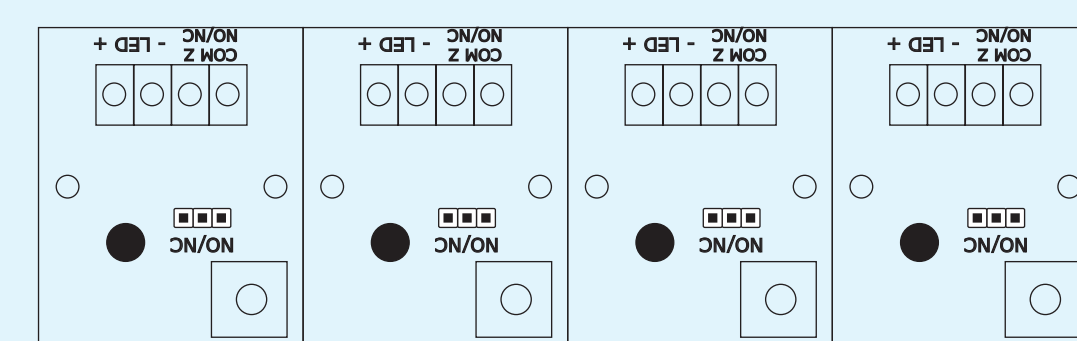
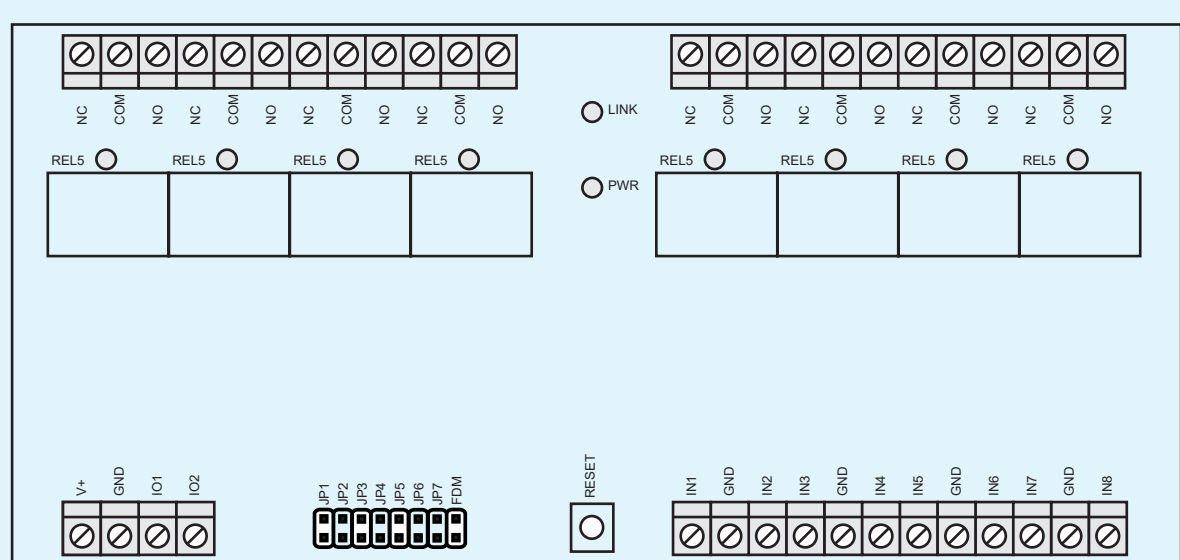

IN1/REL1 IN2/REL2 IN3/REL3 IN4/REL4

**Wiegand 1** **Wiegand 2**

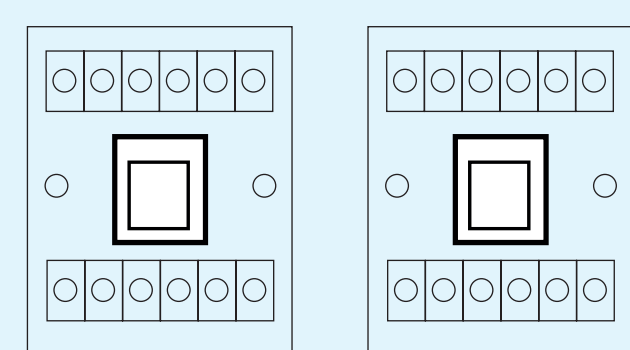

**RS485 A**

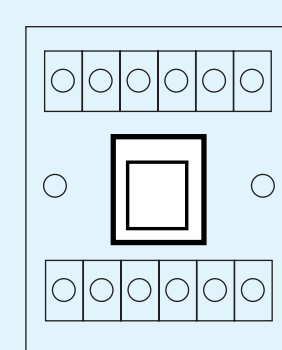

**MC16**  
Kontroler dostępu

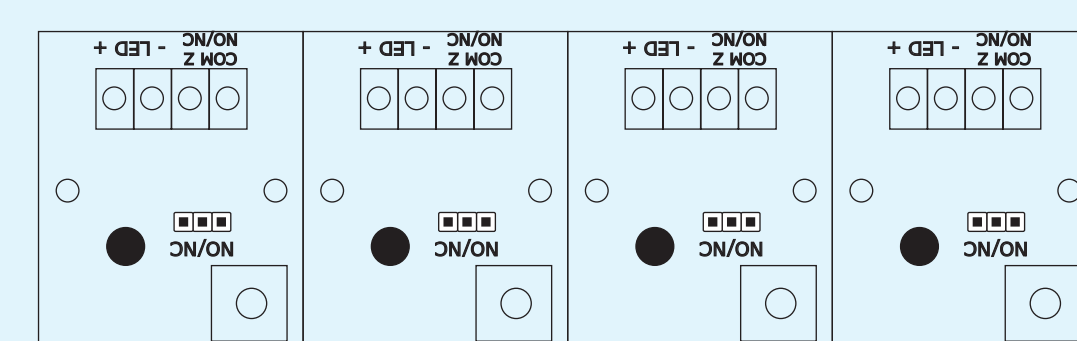
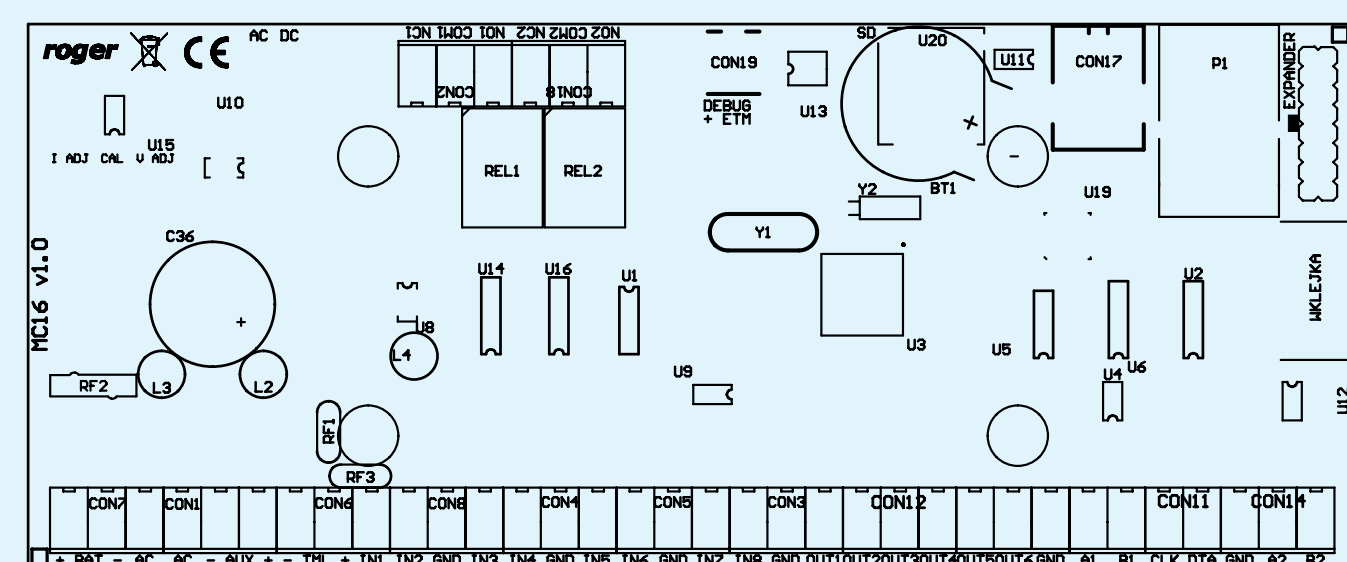

IN5/OUT5 IN6/OUT6 IN7/REL1 IN8/REL2

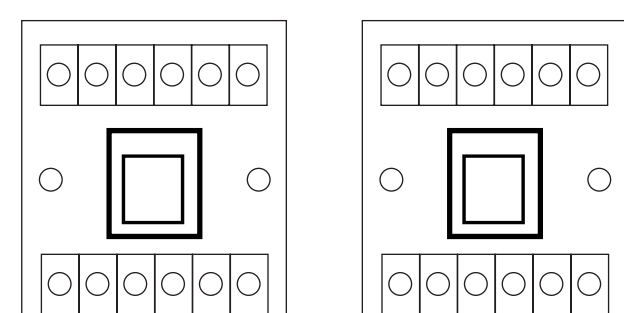

RS485 B

RACS CLK/DTA

**RUD-1** Interfejs komunikacyjny USB-RS485

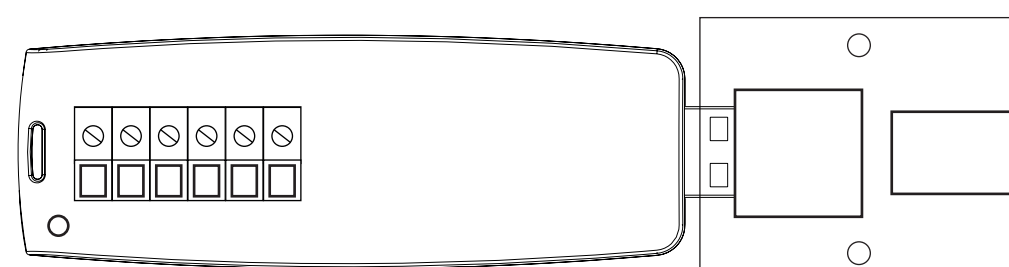

**RUD-3** Czytnik kart 13,56 MHz MIFARE®

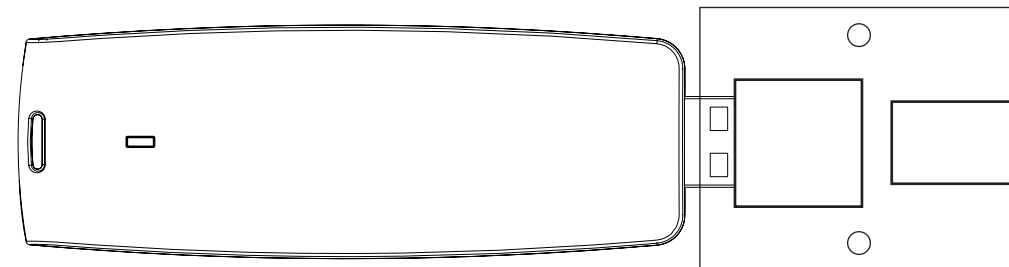

**Legenda**

Magistrala RS485

Połączenia linii we/wy

Magistrala RACS CLK/DTA

ROGER sp. z o.o. sp. k.  
Gościszewo 59  
82-400 Sztum  
T. +48 55 272 0132  
E. roger@roger.pl  
www.roger.pl

